

Hand Operated Curtain Pole System

Silent Gliss® 6100M Metroflat 36mm

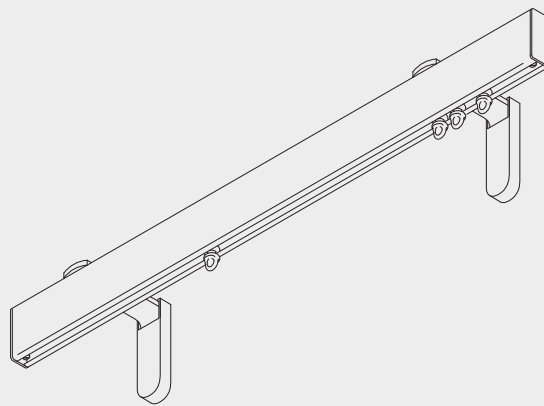

Product Information

- Hand operated system for domestic and contract applications
- Attractive contemporary appearance for modern interiors
- Can be bent to a small radius for bay windows
- Available in 10 finishes - white, matt white, chrome effect, silver, black, slate grey, bronze, anodic grey, ecru and gunmetal
- Accessorised with endcaps or a range of finials
- Easy fitting to wall or ceiling
- For light to medium weight curtains
- Profile length 6m (chrome effect 3.95m)
- Suitable for Wave Standard curtain heading system



6100M

Profile, Bending and Specification Information

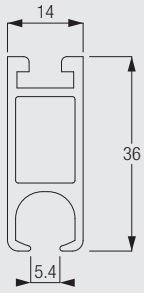

6101



Standard radius 200mm

Specification Information - download from www.silentgliss.co.uk

Silent Gliss 6100M curtain track, hand drawn, aluminium, assembled complete with gliders 6143 at 10/m and 2 endcovers 0351. Face Face fix with brackets 11206-208/11216-218/11209/0334/0989. Top fix with bracket 6138P/ 0335 at 700mm centres. Finished in white, matt white, black, silver, gunmetal, antique bronze, slate grey, ecru, anodic grey or chrome effect.

How To Measure

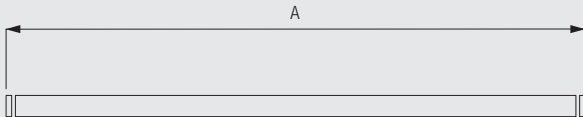

A: System Width - includes finials. See 'Design Options' for finial sizes.

Stack Size Calculation Wave

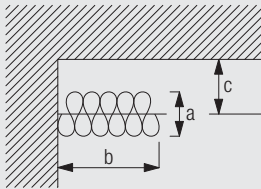

6100M

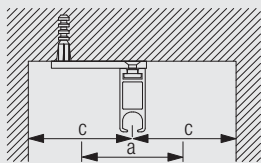

a = Stack depth
b = Stack size
c = Min. distance

Glider-cord spacing	Curtain hook spacing	Approx. curtain fullness	Stack depth (a)	Stack width (b)	Min distance (c)
6	10	2.1	10	23 per metre of track + endpiece	8
6	12	2.3	12	23 per metre of track + endpiece	9
8	14	2.1	14	18 per metre of track + endpiece	10
8	16	2.3	16	18 per metre of track + endpiece	11

Wave standard with roller gliders

Glider-cord spacing	Curtain hook spacing	Approx. curtain fullness	Stack depth (a)	Stack width (b)	Min distance (c)
8	14	2.1	14	21 per metre of track + endpiece	10
8	16	2.3	16	21 per metre of track + endpiece	11

(dimensions in cm)

Note: Minimum distance (c) includes a standard 3cm clearance (front and back).

Design Options

Endcaps

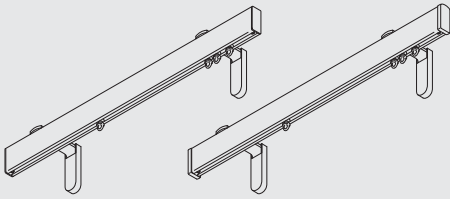

Without finials, poles are supplied as standard with flush fitting endcaps 0351 (left). Alternatively, stud endcaps 0710 (right) can be selected at no additional cost.

Finials

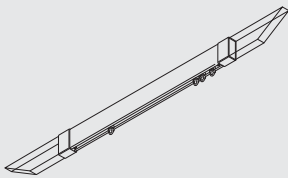

Finials are decorative elements that fix to the end of the pole.

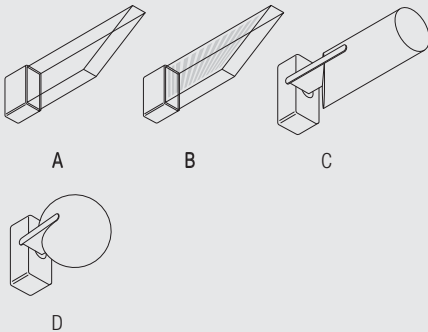

- A: 0991CL Shard (clear) 116mm
- B: 0991ET Shard (etched) 116mm
- C: Fused Barrel (walnut/oak/colour matched) 102mm
- D: Fused Ball (walnut/oak/colour matched) 63mm

Please consult the Metropole Brochure for full range details.

Wave Standard curtain heading system

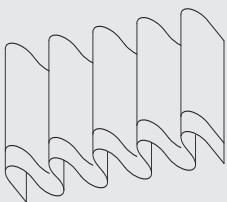

The Wave curtain heading system is an exciting contemporary curtain heading system which allows curtains to hang in a continuous wave which is smooth, simple and elegant.

When using the Wave curtain heading system please note the maximum recommended curtain weight is 2.5kg/m or 10kg/m with wave roller glider 6098W.



6100M

The Wave standard components are:

- 6345 Glider Cord 60mm
- 6346 Glider Cord 80mm
- 6007 End stop

The items listed below for Enhanced Wave (80mm glider cord only) are all supplied at an additional cost as per the price list.

- 2255 Adjustable brake
- 6364 Extension (for use with 6365)
- 6365 Hanger (for use with 6364)
- 6366 Carrier for draw rod

Roller gliders must be ordered separately
6098W Wave roller glider 80mm

Optional enhanced components to improve the presentation of the curtain:

- 3582 Hook
- 6349 Curtain tape
- 6363 Iron-on top hemming tape
- 10075 Lead weight for bottom hem 50gr/m
- 10076 Fabric weight for side of curtain

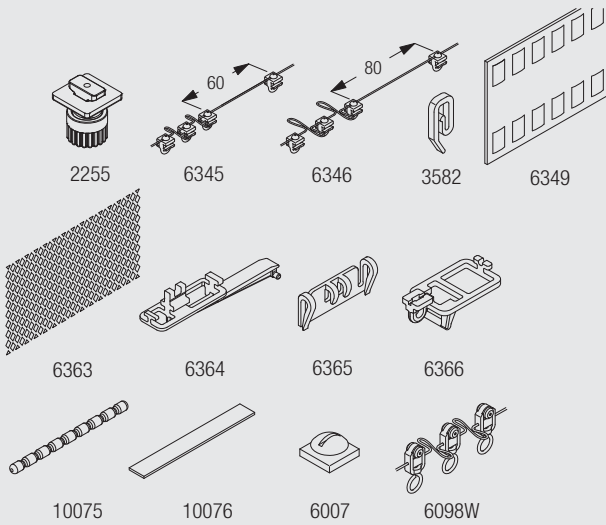

Fitting Information

Bracket positioning

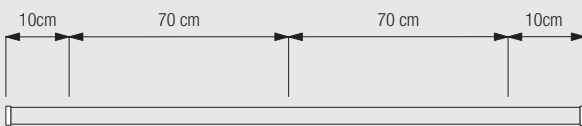

6100M

Fitting of track to brackets

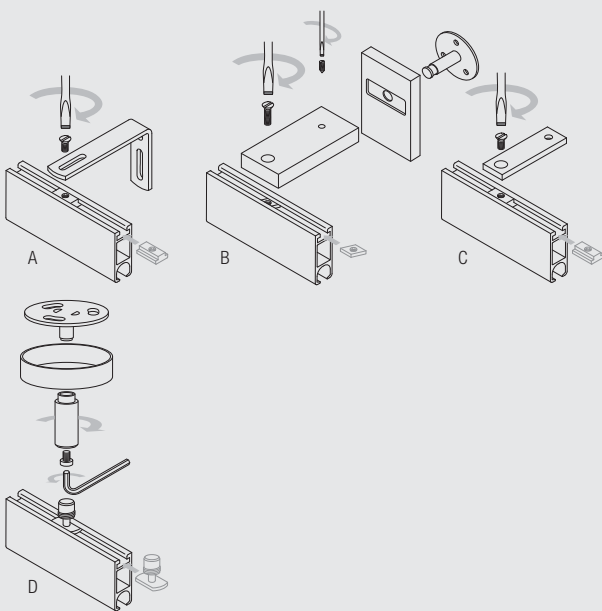

- A: Using bracket set 11206-11208/11216-218/11209
- B: Using Blok brackets 0989
- C: Using top fix plate 6138P
- D: Using top fix bracket 0335

Fitting bent tracks.

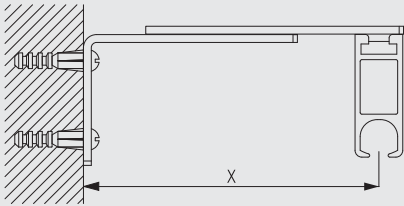

Note: all bent Metropole systems are supplied with adjustable bracket set 11209 as standard.

X = 80-100mm

Fitting Options

Wall fix with Blok brackets 0989

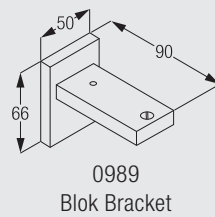
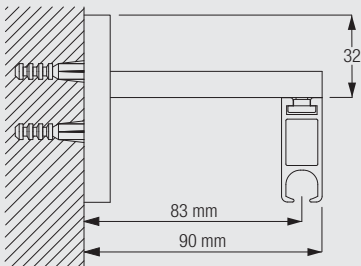

The final distances may be outside of the recommendations above depending on curtain heading, make-up and any obstructions.

Ceiling fix with support 6138P

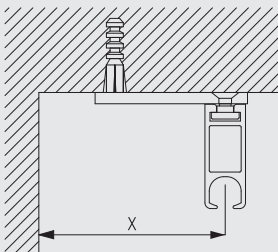

X (mm)
80

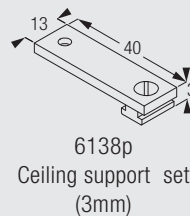

6100M

The final distances may be outside of the recommendations above depending on curtain heading, make-up and any obstructions.

Wall fix with adjustable Smartfix bracket 11209

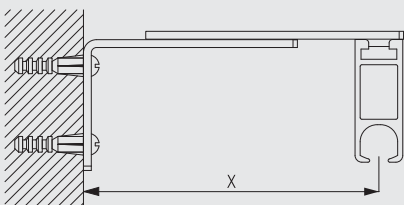

X (mm)
11209 80-100

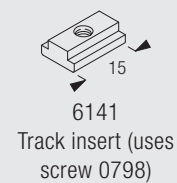
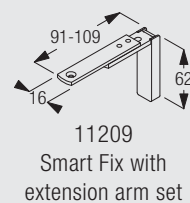

Brackets feature slot for screw M4x8

The final distances may be outside of the recommendations above depending on curtain heading, make-up and any obstructions.

All bent Metroflat 36mm systems are supplied with adjustable bracket set 11209 as standard.

Ceiling Fix with Top Fix Bracket 0335

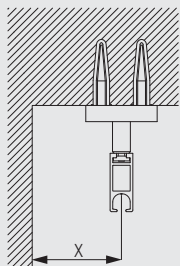

	X
0334	80

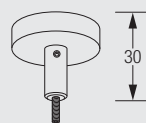

0335
Top fix bracket

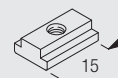

6141
Track insert (uses
screw 0798)

Wall fitting with Smart Fix with slot 11206-11208

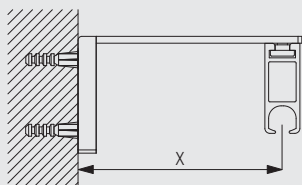

	X (mm)
11206	33-51
11207	53-71
11208	73-91

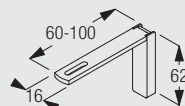

11206-08
Smart Fix with slot
(60-100 mm)

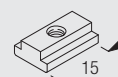

6141
Track insert (uses
screw 0798)

Brackets feature slot for screw M4x8

Wall fitting with Square Smart Fix with slot 11216-11218

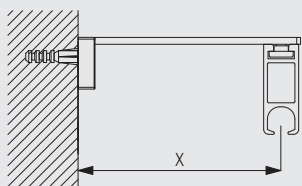

	X (mm)
11216	33-51
11217	53-71
11218	73-91

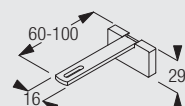

11216-18
Square Smart Fix
with slot (60-100
mm)

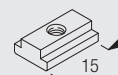

6141
Track insert (uses
screw 0798)

Brackets feature slot for screw M4x8



6100M

Standard Accessories

Parts

0351	Metroflat end cap	
------	-------------------	--

6065	Twist eye endstop	
------	-------------------	--

6101	Profile	
------	---------	--

6141	Track insert (uses screw 0798)	
------	--------------------------------	--

6143	Glider 6144 in strip form	
------	---------------------------	--

6784	Machine screw (for 6141 insert)	
------	---------------------------------	--

11206	Smart Fix, 60 mm with slot set	
-------	--------------------------------	--

11209	Smart Fix with extension arm set	
-------	----------------------------------	--

Optional Accessories

Parts

0304	Fused barrel (36mm)		0318	Fused ball (36mm)	
0335	Top fix bracket		0710	Stud Endcap	
0989	Blok Bracket		2216	Cord	
6283	Roller glider		6398	Clip	
11207	Smart Fix, 80 mm with slot set		11208	Smart Fix, 100 mm with slot set	
11209	Smart Fix with extension arm set		11216	Square Smart Fix, 60 mm with slot set	
11217	Square Smart Fix, 80 mm with slot set		11218	Square Smart Fix, 100 mm with slot set	
6138p	Ceiling support set (3mm)		0991CL	Shard Clear Metroflat	
0991ET	Shard Etched Metroflat				

Wave Accessories



6100M

2255	Adjustable brake		3582	Hook	
6007	Endstop		6345	Wave glider cord (60mm)	
6346	Wave glider cord (80mm)		6349	Wave curtain heading tape	
6363	Top hemming tape		6364	Extension	
6365	Hanger		6366	Wave carrier for draw rod	
10075	Lead weight 50 gr/m		10076	Fabric weight	
6098W	Wave roller glider cord (80mm)				



6100M